



**联达金属**  
**LIANDA**

**WWW.WXLIANDA.CN**

**无锡市联达金属制品有限公司**

**WUXI LIANDA METAL PRODUCT CO., LTD**

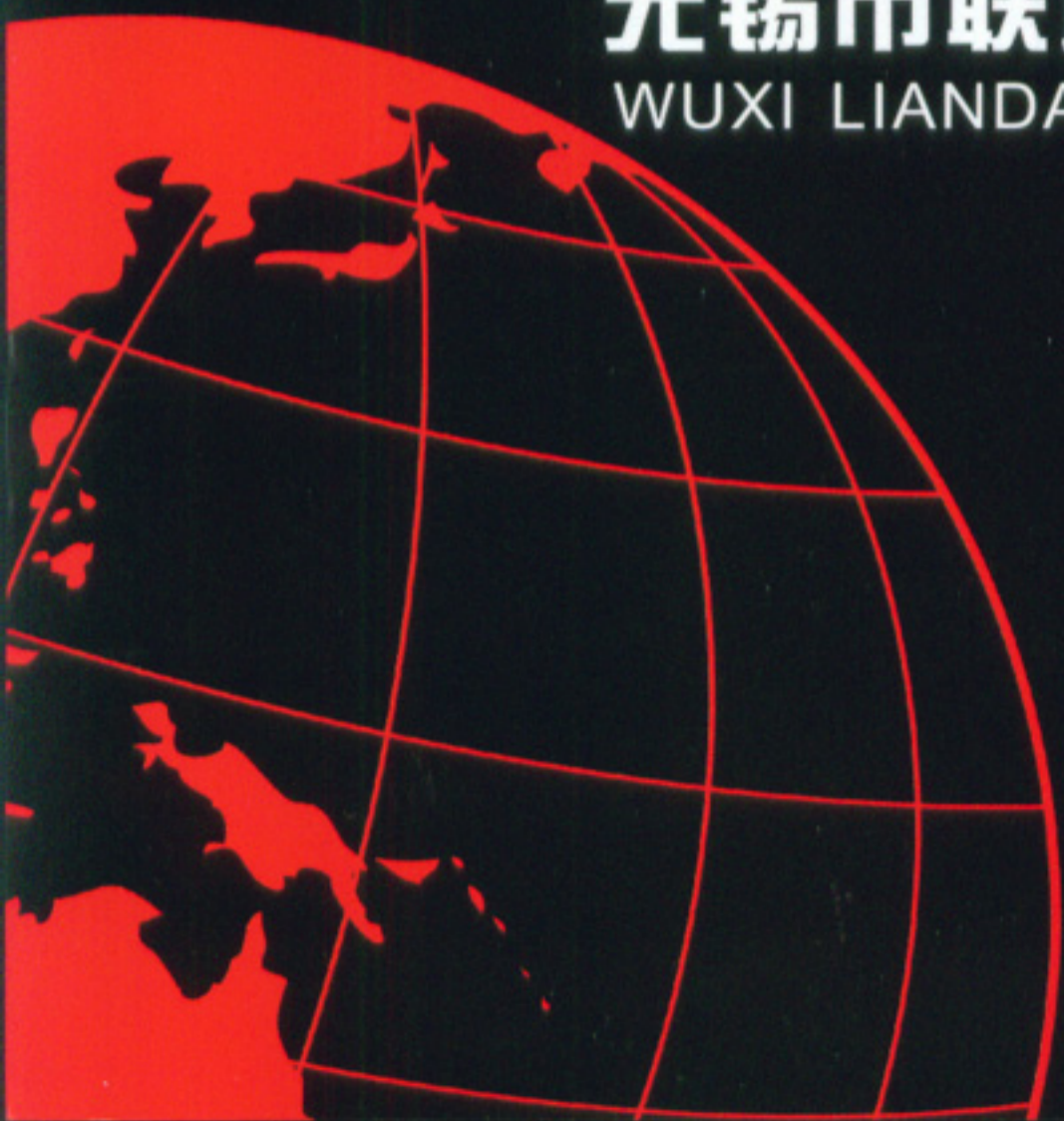

# 公司简介 About us

无锡市联达金属制品有限公司位于长江三角区经济发达、资源丰富、风景秀美的太湖之滨-无锡市钱桥镇。这里地理条件优越，交通便利，毗邻312国道和342省道，北接沪宁、锡宜高速，距锡宜高速钱桥出口仅1公里，南望风景秀丽的太湖大道。

公司占地5300平方米，拥有现代化的标准厂房4000平方米，配备全新的冷弯生产线及大型折弯机，是各种高低压电器开关柜、金属柜配套型材的专业生产厂家。专业生产KS(8MF)型材，FA-38/28型材，PS九折型材，KB“C”型材，同时生产KS、FA、KB、PS系列组装式柜体结构件，具有精度高、零件少、装折方便等特点，并能按标准化、通用化、系列化要求组织生产。

公司始终坚持以人为本的企业理念，以重质量创名牌为企业宗旨，狠抓产品质量管理，逐步实现生产、检测、销售、服务一体化。本公司愿以最佳的质量，最优的价格，最好的服务，向广大用户提供标准化、非标的，适用于高低压成套设备的机箱、机柜、型材及柜架和附件。

联达金属竭诚为客户提供质量可靠的产品和优质的服务，携手新老客户共创辉煌的明天！

**沟通无障碍，品质决定未来。**





精良的装备，品质的保证



## KS (8MF) 型材系列

KS型材是仿德国西门子公司设计的电气设备柜体结构型材，广泛应用于GGD、GCS、XGB、直流屏、继电保护屏中。

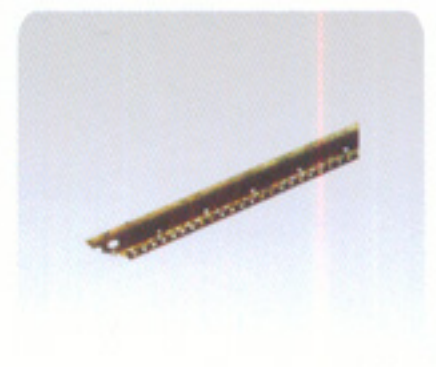
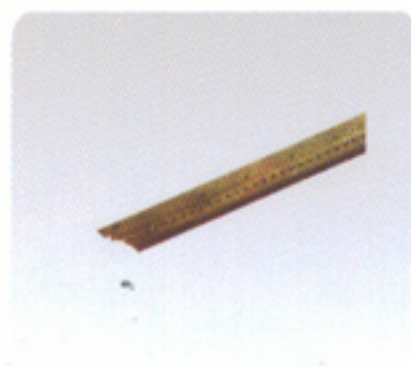
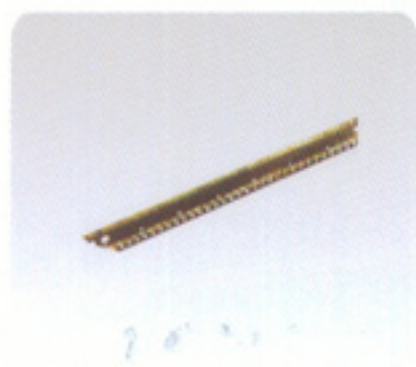
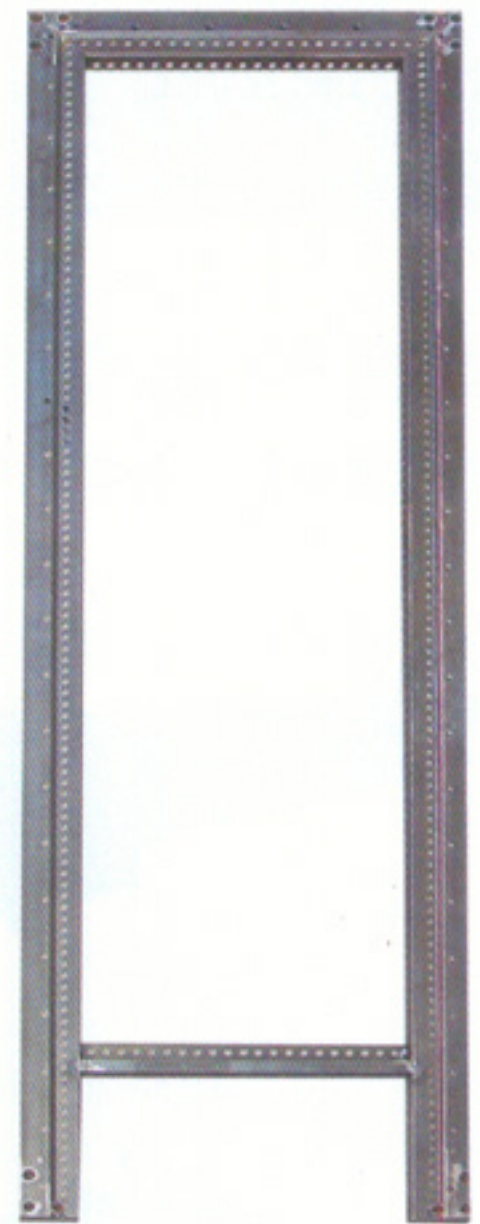

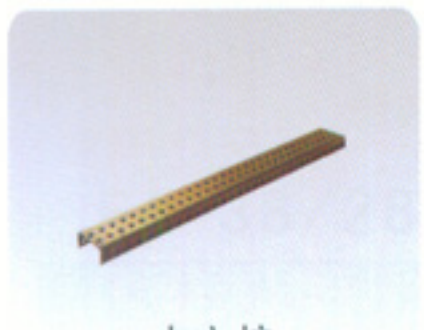

中立柱



侧横梁



侧上横梁



横梁



门挡条



门横梁



断路器安装梁



刀开关安装梁

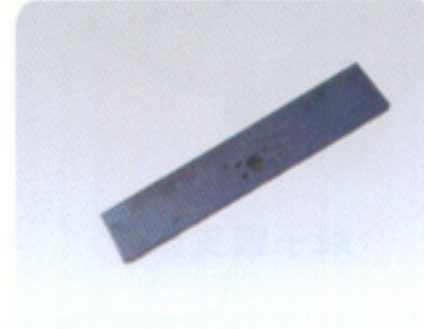

刀开关旋转梁

## KS (8MF) 系列主要技术参数

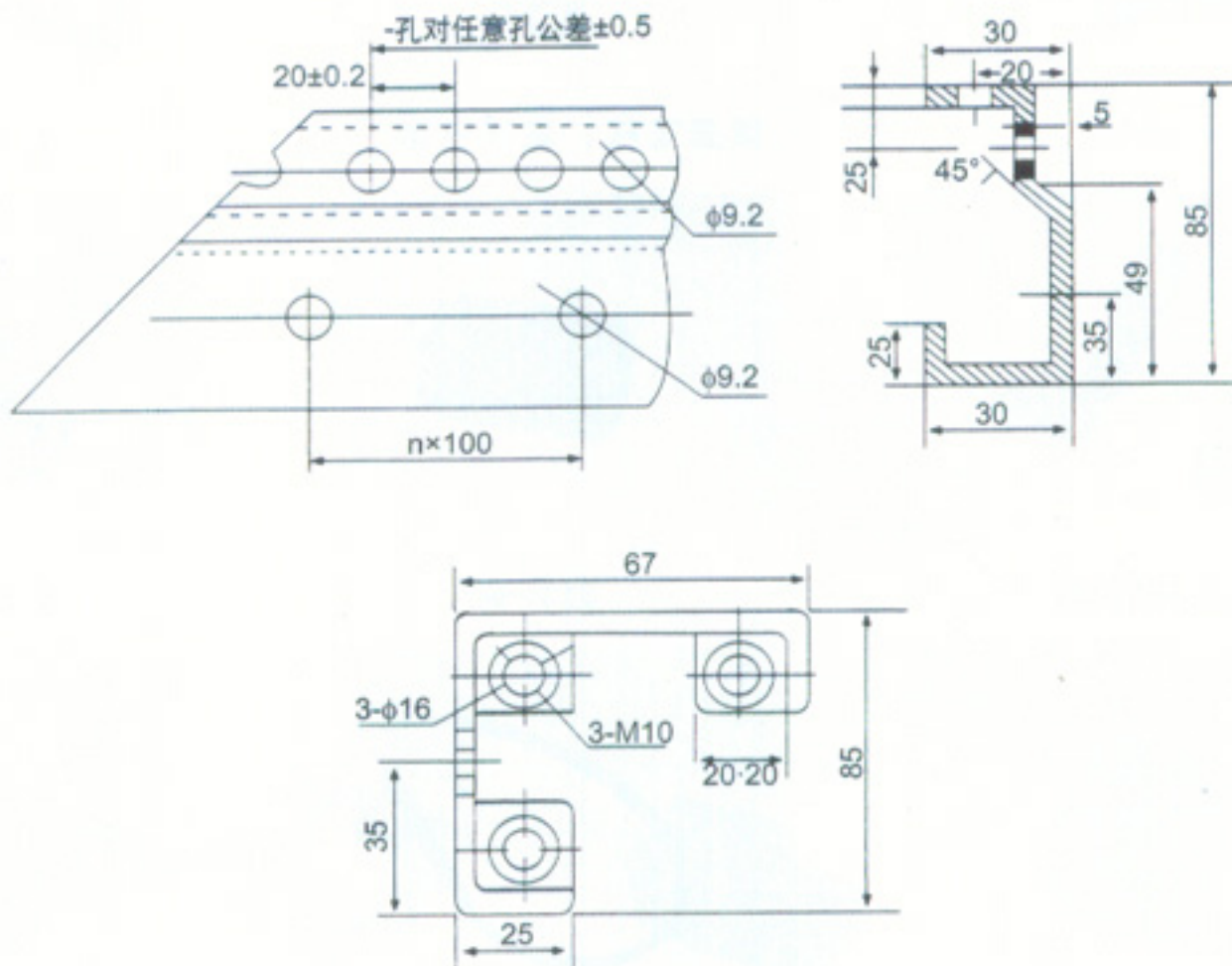

# GGD成套配件系列

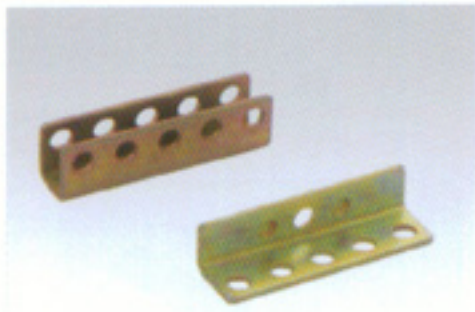

单、双支架



联接件



门锁

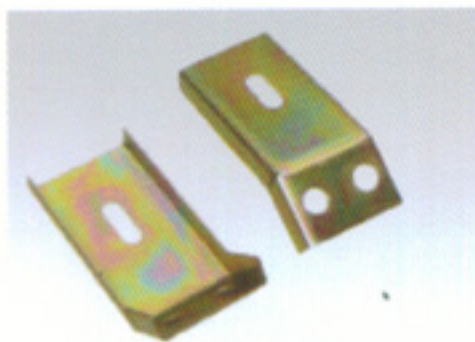

端子板支架

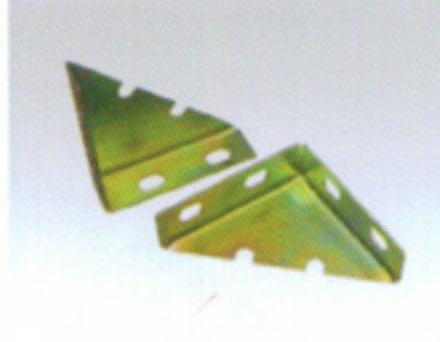

三角支架

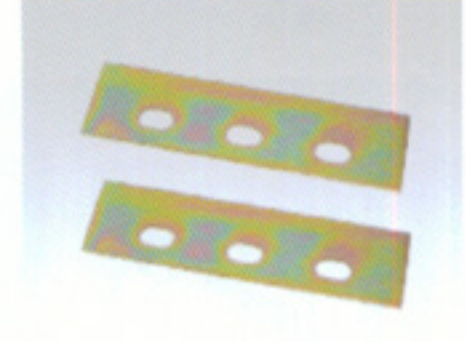

垫板



吊环

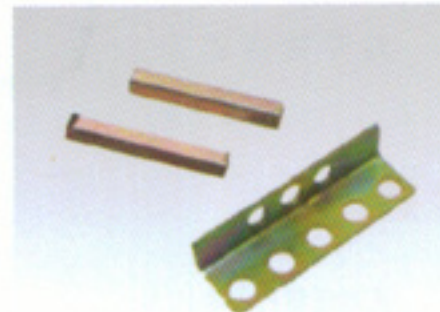

顶盖支柱、底板支架

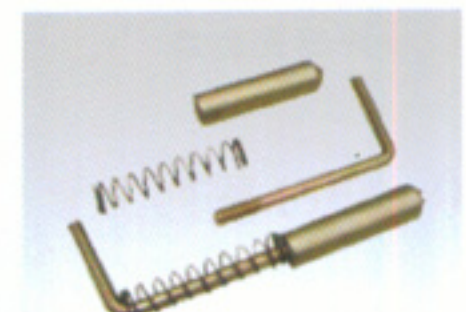

上下门轴



挂钩螺套



锁杆套



定位圆套



定位方套



密封条



眉头、螺丝

## FA-38/28型材系列

FA-38/28型材是仿德国AEG公司设计的电气设备柜体结构型材，广泛应用于GCK、GKH、GBD、XL-21及非标控制柜。

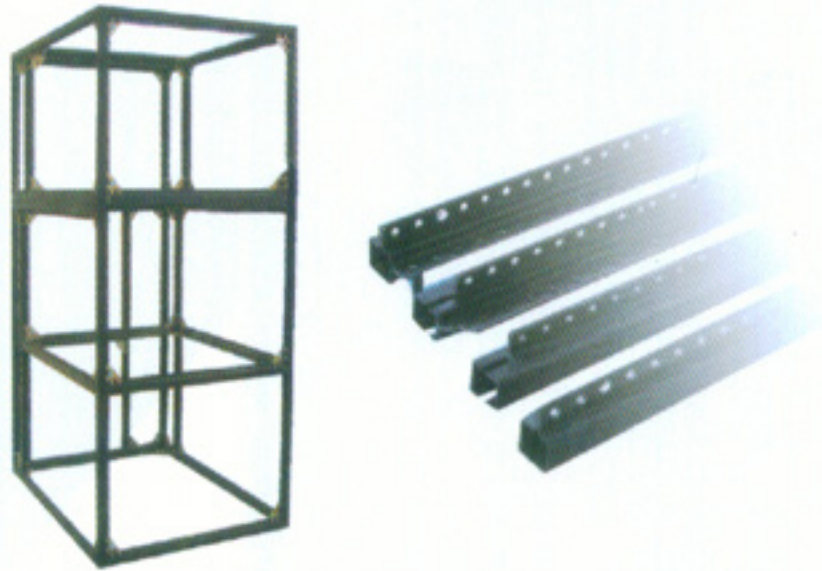

### FA-38系列主要技术参数

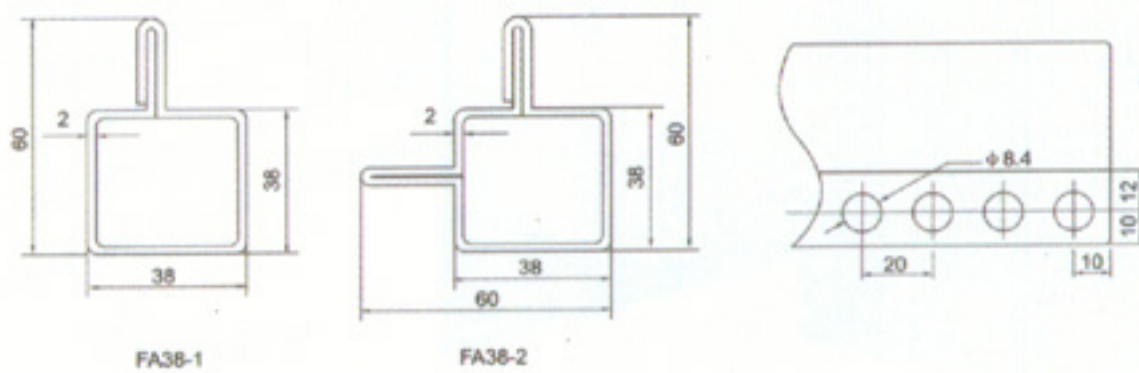

### FA-28系列主要技术参数

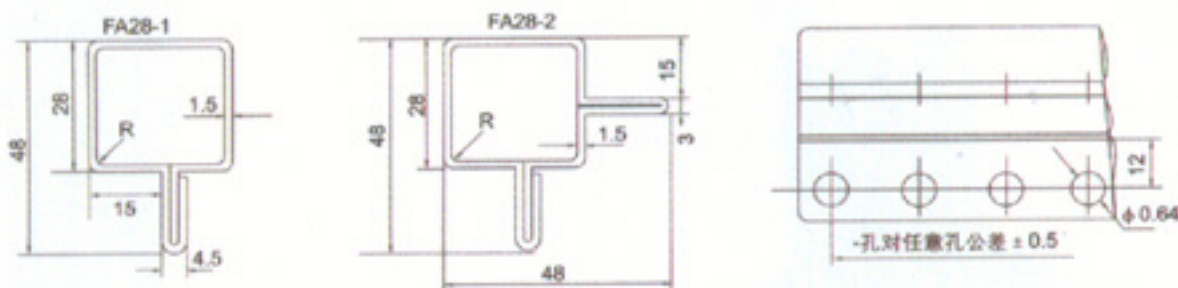

XGN2高压单片角板 (38型) XGN2高压铰链 (38型)

铝单通

铝三通 (38型)

## PS九折型材系列





## PS九折系列附件图

### ★系列附件参数图

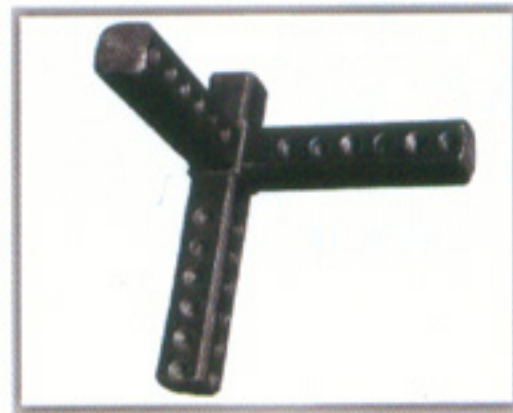
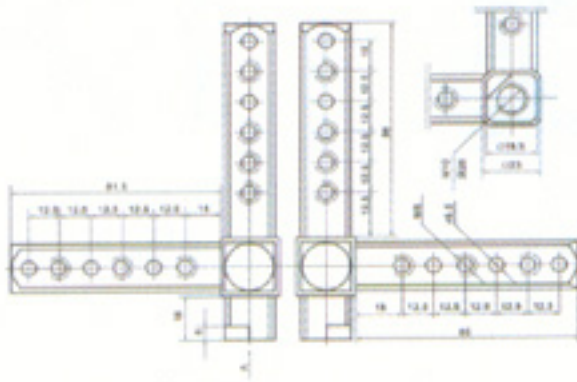

类别：型钢角部件

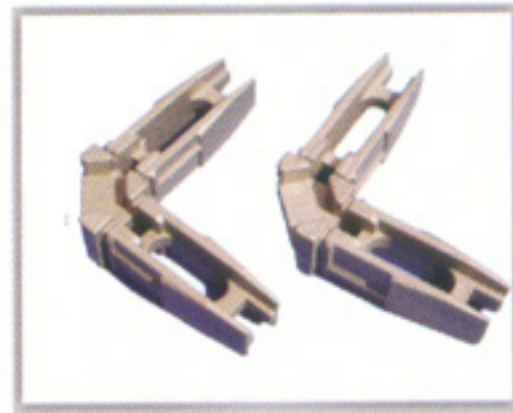
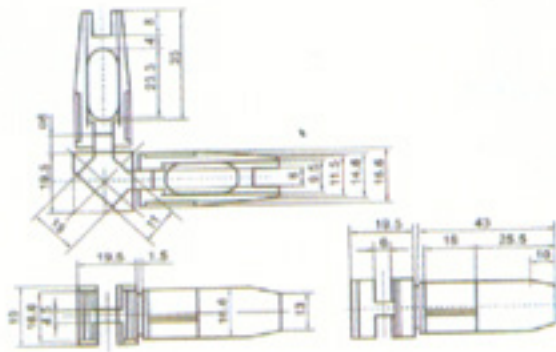

类别：加强筋连接件

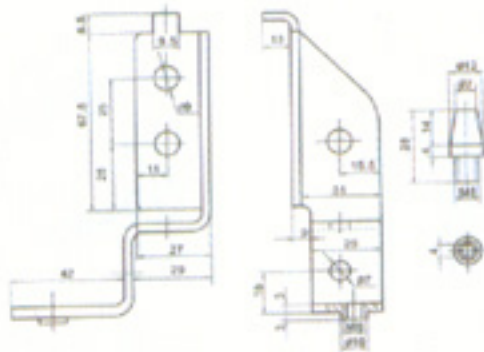

类别：左右挂件

### ★主要技术参数

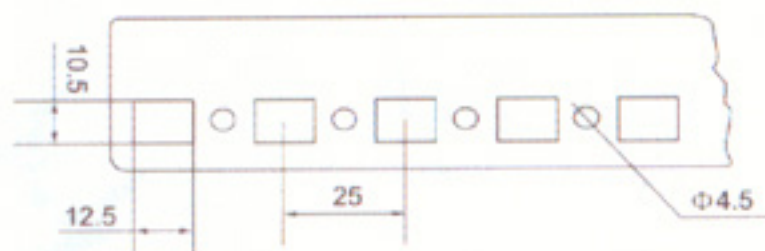
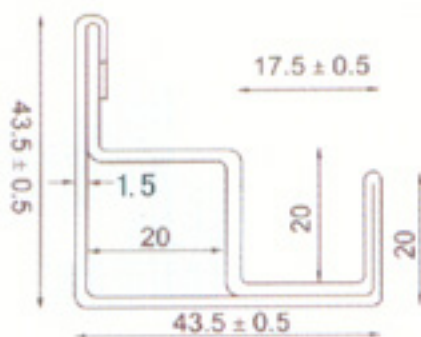

## PS九折系列附件图



130度铰链



烽火锌合金铰链



AE箱锁



方螺母



AE箱铰链



并柜运输角



单门锁、锁点、锁套



后板螺钉



加强筋螺母



侧板附件



底板附件



门板托架

## PS九折系列附件图



文件袋



密封条



KL箱附件



角轮

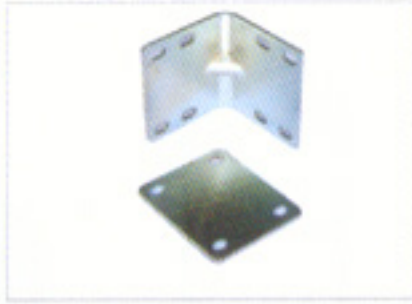

并柜连接件



大把锁



平面锁



摇把锁

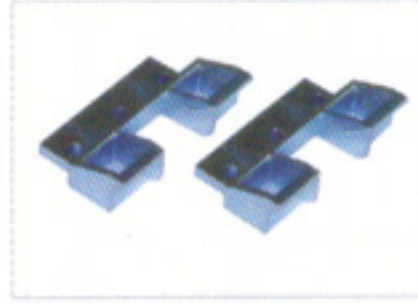

双门锁档块



门限位



锁杆系列



安装板附件

## KB “C” 型材系列

KB “C” 型材系列是消化吸收国外ABB公司先进技术，采用25mm模数孔的冷滚弯工艺生产的换代产品，广泛应用于GCK、MNS、断电保护柜及变压器等产品。

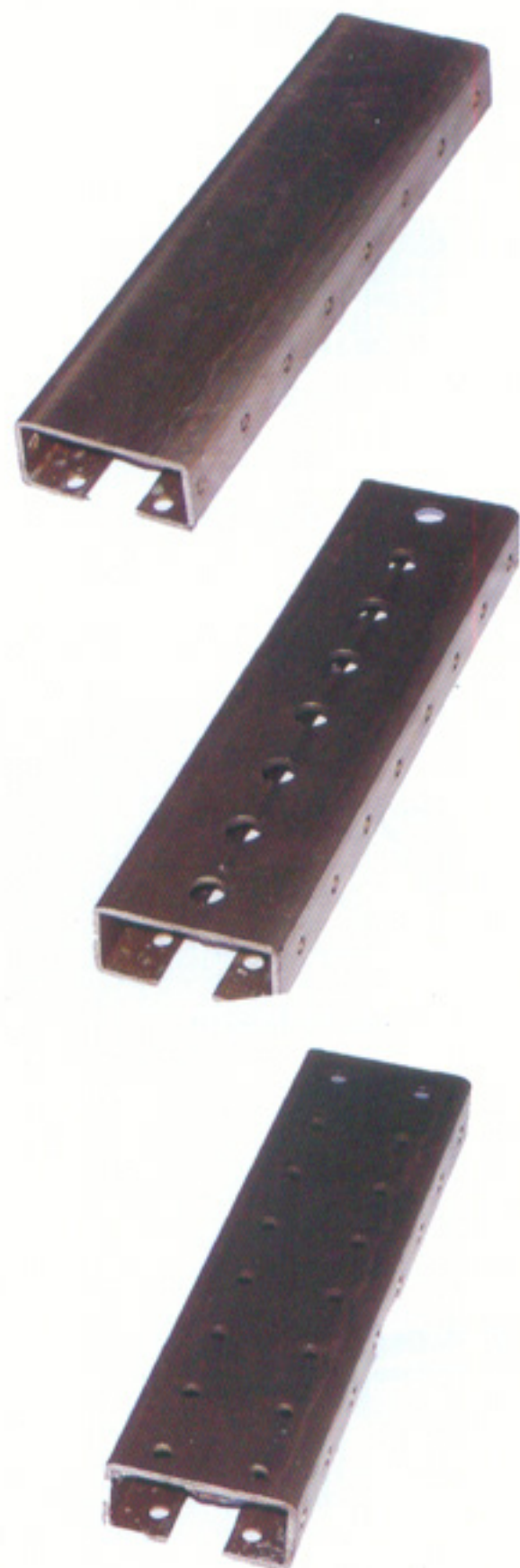
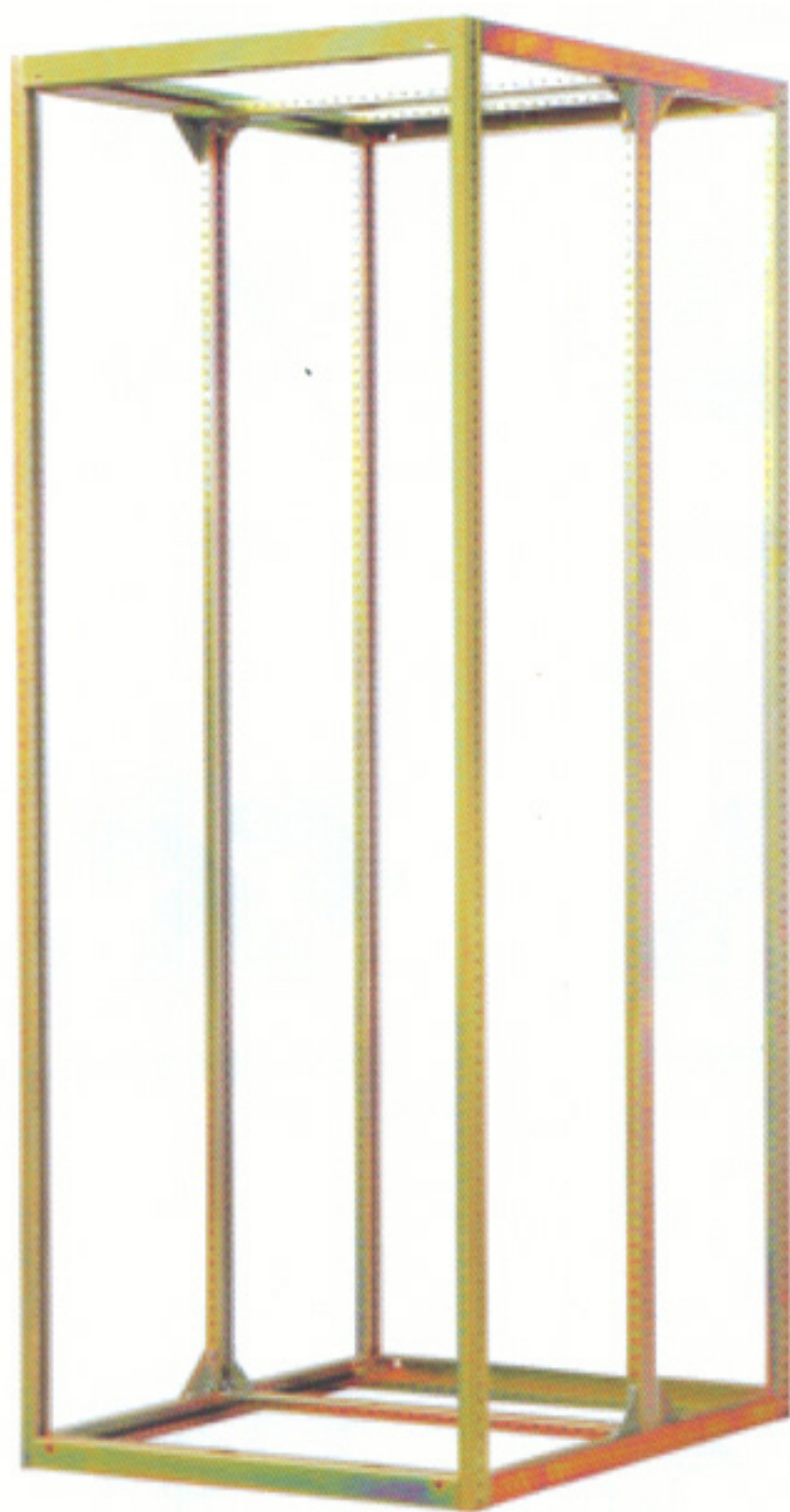

## KB “C” 系列附件图

### ★ KB “C” 系列主要技术参数

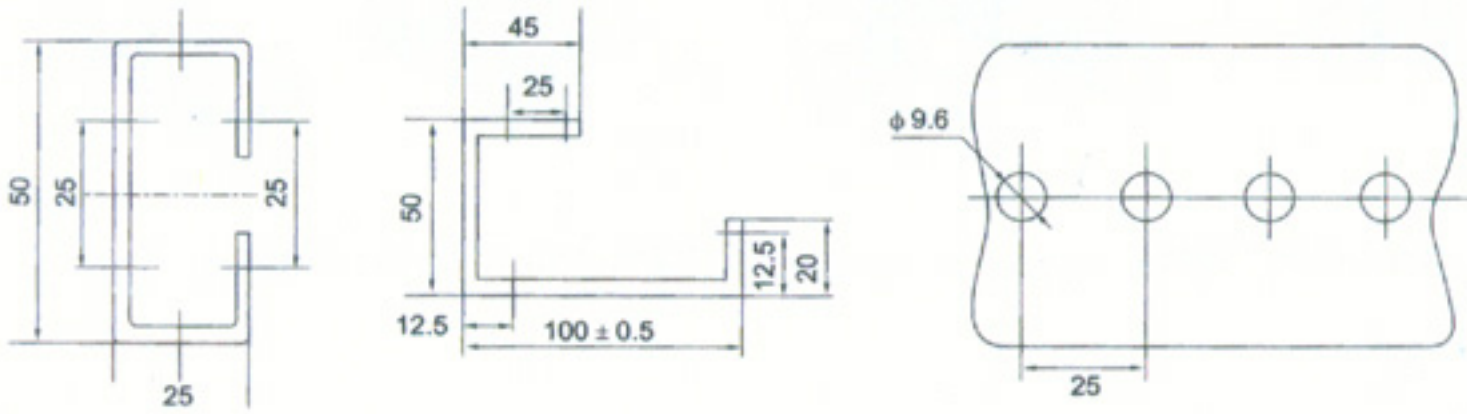

抽屉铰链



锁沟



堵头三通连接板



MNS大三角  
(采用C型材铝三通)



箱体铰链



五孔铰链

## KB “C” 系列附件图

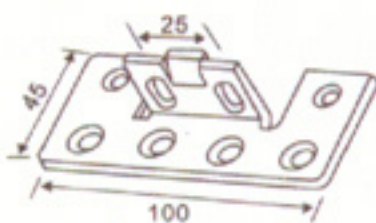
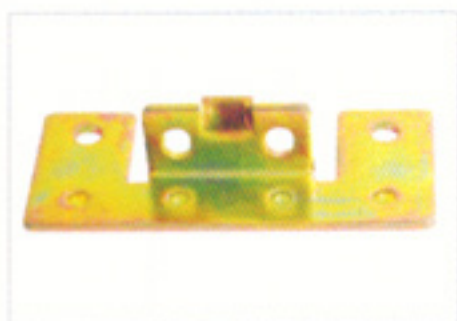

GLBK 400 006P (撑板)

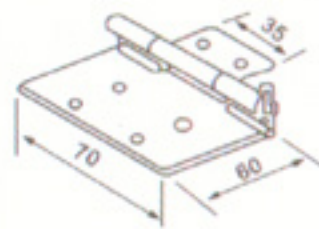

GLBK 410 000-1门铰链

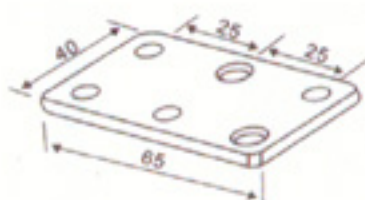

GLBK 400 011P1连接板

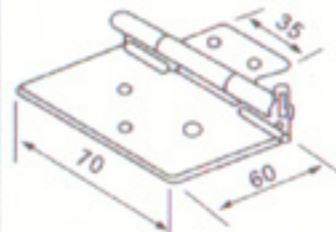

GLBK 410 000-2门铰链

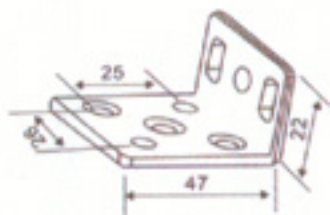

GLBK 400 007P1带定位角板

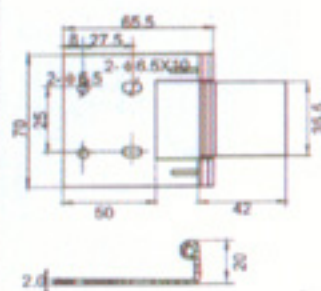

GLBK 410 000-3门铰链

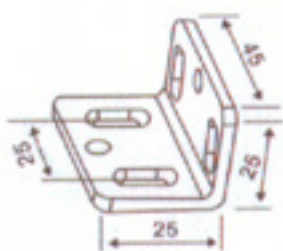

GLBK 400 007P1无定位角板

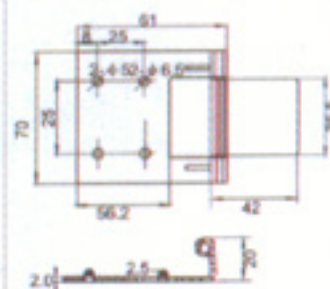
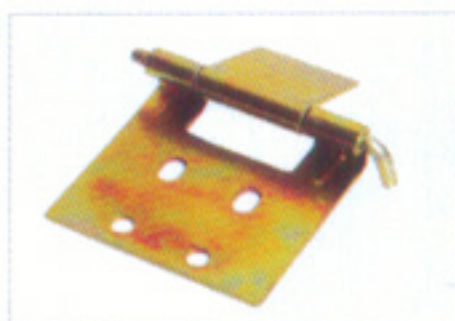

GLBK 410 000-4门铰链

KB “C” 系列附件图

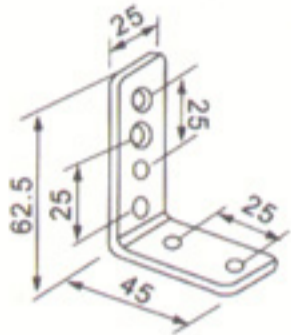

GLBK 300 094支件

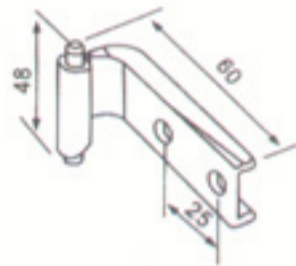

GLBK 410 027R1铰链

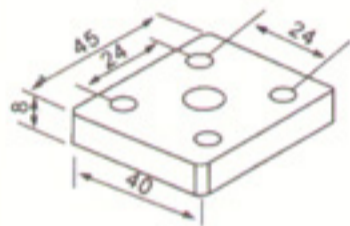

GLBK 400 004P2压板

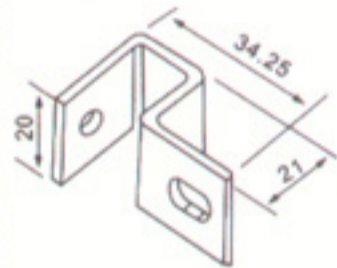

GLBK 410 005P2紧固件

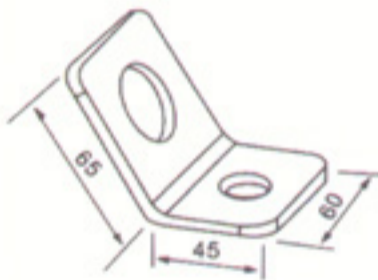

GLBK 500 0045运输角

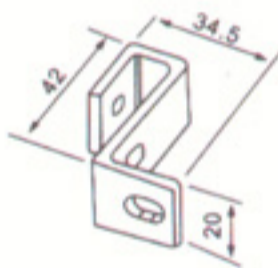

GLBK 410 005P1紧固件

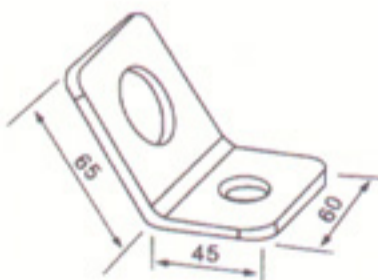

GLBK 500 无销角 (小)

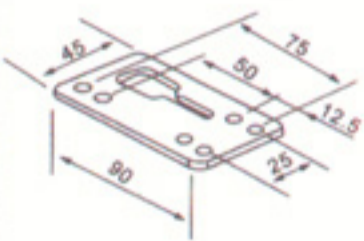
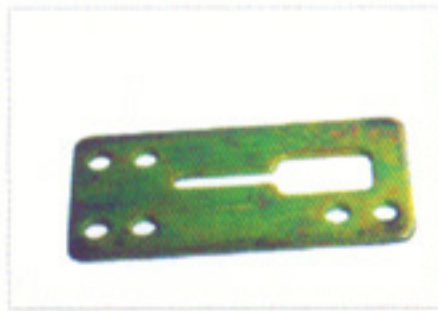

GIILG 530 074铰链



完美品质 优质保障

## 无锡市联达金属制品有限公司

地址：无锡惠山经济开发区钱桥配套区锦溢路8号  
 电话：0510-83206160 0510-83218160  
 传真：0510-83206160  
 手机：13921155280  
 联系人：谈先生  
 邮箱：sales@wxlianda.cn  
 网址：www.wxlianda.cn